

ARLES

アルル
DESIGN : ATELIER D.Q.

ITEM VARIATION



SOFA 3-SEATER



SOFA 1-SEATER



CHAISE LONGUE



ARM COVER

SPECIFICATION

[標準仕様] 木部 : ビーチ (ウレタン塗装 NL・WN・WE・WH・BK)
脚部 : ロクロ脚 (真鍮キャップ)
角脚
背クッション : 粒状ポリエステル
座クッション : ウレタンフォーム+粒状ポリエステル
ソファ脚高 : H100mm

[特記事項] ・背・座クッション : カバーリングタイプ
・ソファ本体 : 張込みタイプ

[VISUAL PAGE 掲載] P092-095

[アップグレード] 木部 : ビーチ (マットウレタン塗装 mTG・mBK)

FEATURES

LEGS VARIATION

脚部はロクロ脚と角脚からお選びいただけます。

脚部



ロクロ脚



角脚

ITEM / SIZE

ITEM NO.

LEGS

WOOD

PRICE

SOFA 1-SEATER

ソファ 1人掛



W860×D950×H845 SH380 AH555

ARLES 952
アルル 952

ロクロ脚

ビーチ (ウレタン塗装) NL WN WE
WH BK

ARLES 483
アルル 483

角脚

ビーチ (ウレタン塗装) NL WN WE
WH BK

FABRIC		LEATHER	
R	284,900	AL	465,300
I	315,700	L	541,200
T	346,500	LE	617,100
Z	377,300	LX	723,800
👤	234,300	※張地をご支給の場合	

SOFA 3-SEATER

ソファ 3人掛 (クッション2分割)



W1820×D950×H845 SH380 AH555

ARLES 953
アルル 953

ロクロ脚

ビーチ (ウレタン塗装) NL WN WE
WH BK

ARLES 484
アルル 484

角脚

ビーチ (ウレタン塗装) NL WN WE
WH BK

FABRIC		LEATHER	
R	521,400	AL	837,100
I	584,100	L	972,400
T	646,800	LE	1,107,700
Z	709,500	LX	1,299,100
👤	420,200	※張地をご支給の場合	

SOFA 3-SEATER (L)

ソファ 3人掛 (L) (クッション2分割)



W2100×D950×H845 SH380 AH555

ARLES 151
アルル 151

ロクロ脚

ビーチ (ウレタン塗装) NL WN WE
WH BK

ARLES 153
アルル 153

角脚

ビーチ (ウレタン塗装) NL WN WE
WH BK







FABRIC		LEATHER	
R	581,900	/	
I	642,400		
T	702,900		
Z	763,400		
👤	482,900	※張地をご支給の場合	

■ URETHANE FINISH COLOR : NL (ナチュラル)・WN (ウォールナット)・WE (ウェンジ)・WH (ホワイト)・BK (ブラック)・mTG (マットアップグレー)・mBK (マットブラック)

ARLES



アルル

DESIGN : ATELIER D.O.

ITEM / SIZE	ITEM NO.	LEGS	WOOD	PRICE																								
SOFA 3-SEATER (L) ソファ 3人掛 (L) (クッション3分割)	ARLES 152 アルル 152	ロクロ脚	ビーチ (ウレタン塗装)	<input type="checkbox"/> NL <input type="checkbox"/> WN <input type="checkbox"/> WE																								
				<input type="checkbox"/> WH <input type="checkbox"/> BK																								
	ARLES 154 アルル 154	角脚	ビーチ (ウレタン塗装)	<input type="checkbox"/> NL <input type="checkbox"/> WN <input type="checkbox"/> WE																								
				<input type="checkbox"/> WH <input type="checkbox"/> BK																								
W2100xD950xH845 SH380 AH555				<table border="1"> <thead> <tr> <th colspan="2">FABRIC</th> <th colspan="2">LEATHER</th> </tr> </thead> <tbody> <tr> <td>R</td> <td>630,300</td> <td>AL</td> <td>976,800</td> </tr> <tr> <td>I</td> <td>704,000</td> <td>L</td> <td>1,129,700</td> </tr> <tr> <td>T</td> <td>777,700</td> <td>LE</td> <td>1,282,600</td> </tr> <tr> <td>Z</td> <td>851,400</td> <td>LX</td> <td>1,492,700</td> </tr> <tr> <td>👤</td> <td>508,200</td> <td colspan="2">※張地をご支給の場合</td> </tr> </tbody> </table>	FABRIC		LEATHER		R	630,300	AL	976,800	I	704,000	L	1,129,700	T	777,700	LE	1,282,600	Z	851,400	LX	1,492,700	👤	508,200	※張地をご支給の場合	
FABRIC		LEATHER																										
R	630,300	AL	976,800																									
I	704,000	L	1,129,700																									
T	777,700	LE	1,282,600																									
Z	851,400	LX	1,492,700																									
👤	508,200	※張地をご支給の場合																										
SOFA 3-SEATER (LL) ソファ 3人掛 (LL) (クッション2分割)	ARLES 954 アルル 954	ロクロ脚	ビーチ (ウレタン塗装)	<input type="checkbox"/> NL <input type="checkbox"/> WN <input type="checkbox"/> WE																								
				<input type="checkbox"/> WH <input type="checkbox"/> BK																								
	ARLES 485 アルル 485	角脚	ビーチ (ウレタン塗装)	<input type="checkbox"/> NL <input type="checkbox"/> WN <input type="checkbox"/> WE																								
				<input type="checkbox"/> WH <input type="checkbox"/> BK																								
W2340xD950xH845 SH380 AH555				<table border="1"> <thead> <tr> <th colspan="2">FABRIC</th> <th colspan="2">LEATHER</th> </tr> </thead> <tbody> <tr> <td>R</td> <td>591,800</td> <td colspan="2" rowspan="5" style="text-align: center;">/</td> </tr> <tr> <td>I</td> <td>657,800</td> </tr> <tr> <td>T</td> <td>723,800</td> </tr> <tr> <td>Z</td> <td>789,800</td> </tr> <tr> <td>👤</td> <td>490,600</td> <td>※張地をご支給の場合</td> </tr> </tbody> </table>	FABRIC		LEATHER		R	591,800	/		I	657,800	T	723,800	Z	789,800	👤	490,600	※張地をご支給の場合							
FABRIC		LEATHER																										
R	591,800	/																										
I	657,800																											
T	723,800																											
Z	789,800																											
👤	490,600			※張地をご支給の場合																								
SOFA 3-SEATER (LL) ソファ 3人掛 (LL) (クッション3分割)	ARLES 493 アルル 493	ロクロ脚	ビーチ (ウレタン塗装)	<input type="checkbox"/> NL <input type="checkbox"/> WN <input type="checkbox"/> WE																								
				<input type="checkbox"/> WH <input type="checkbox"/> BK																								
	ARLES 497 アルル 497	角脚	ビーチ (ウレタン塗装)	<input type="checkbox"/> NL <input type="checkbox"/> WN <input type="checkbox"/> WE																								
				<input type="checkbox"/> WH <input type="checkbox"/> BK																								
W2340xD950xH845 SH380 AH555				<table border="1"> <thead> <tr> <th colspan="2">FABRIC</th> <th colspan="2">LEATHER</th> </tr> </thead> <tbody> <tr> <td>R</td> <td>639,100</td> <td>AL</td> <td>985,600</td> </tr> <tr> <td>I</td> <td>712,800</td> <td>L</td> <td>1,136,300</td> </tr> <tr> <td>T</td> <td>786,500</td> <td>LE</td> <td>1,287,000</td> </tr> <tr> <td>Z</td> <td>860,200</td> <td>LX</td> <td>1,507,000</td> </tr> <tr> <td>👤</td> <td>515,900</td> <td colspan="2">※張地をご支給の場合</td> </tr> </tbody> </table>	FABRIC		LEATHER		R	639,100	AL	985,600	I	712,800	L	1,136,300	T	786,500	LE	1,287,000	Z	860,200	LX	1,507,000	👤	515,900	※張地をご支給の場合	
FABRIC		LEATHER																										
R	639,100	AL	985,600																									
I	712,800	L	1,136,300																									
T	786,500	LE	1,287,000																									
Z	860,200	LX	1,507,000																									
👤	515,900	※張地をご支給の場合																										
SINGLE ARM SOFA (RIGHT) 右片肘ソファ	ARLES 1701 アルル 1701	ロクロ脚	ビーチ (ウレタン塗装)	<input type="checkbox"/> NL <input type="checkbox"/> WN <input type="checkbox"/> WE																								
				<input type="checkbox"/> WH <input type="checkbox"/> BK																								
	ARLES 1702 アルル 1702	角脚	ビーチ (ウレタン塗装)	<input type="checkbox"/> NL <input type="checkbox"/> WN <input type="checkbox"/> WE																								
				<input type="checkbox"/> WH <input type="checkbox"/> BK																								
W1560xD950xH845 SH380 AH555				<table border="1"> <thead> <tr> <th colspan="2">FABRIC</th> <th colspan="2">LEATHER</th> </tr> </thead> <tbody> <tr> <td>R</td> <td>455,400</td> <td>AL</td> <td>742,500</td> </tr> <tr> <td>I</td> <td>509,300</td> <td>L</td> <td>861,300</td> </tr> <tr> <td>T</td> <td>563,200</td> <td>LE</td> <td>980,100</td> </tr> <tr> <td>Z</td> <td>617,100</td> <td>LX</td> <td>1,157,200</td> </tr> <tr> <td>👤</td> <td>368,500</td> <td colspan="2">※張地をご支給の場合</td> </tr> </tbody> </table>	FABRIC		LEATHER		R	455,400	AL	742,500	I	509,300	L	861,300	T	563,200	LE	980,100	Z	617,100	LX	1,157,200	👤	368,500	※張地をご支給の場合	
FABRIC		LEATHER																										
R	455,400	AL	742,500																									
I	509,300	L	861,300																									
T	563,200	LE	980,100																									
Z	617,100	LX	1,157,200																									
👤	368,500	※張地をご支給の場合																										
SINGLE ARM SOFA (LEFT) 左片肘ソファ	ARLES 1703 アルル 1703	ロクロ脚	ビーチ (ウレタン塗装)	<input type="checkbox"/> NL <input type="checkbox"/> WN <input type="checkbox"/> WE																								
				<input type="checkbox"/> WH <input type="checkbox"/> BK																								
	ARLES 1704 アルル 1704	角脚	ビーチ (ウレタン塗装)	<input type="checkbox"/> NL <input type="checkbox"/> WN <input type="checkbox"/> WE																								
				<input type="checkbox"/> WH <input type="checkbox"/> BK																								
W1560xD950xH845 SH380 AH555				<table border="1"> <thead> <tr> <th colspan="2">FABRIC</th> <th colspan="2">LEATHER</th> </tr> </thead> <tbody> <tr> <td>R</td> <td>455,400</td> <td>AL</td> <td>742,500</td> </tr> <tr> <td>I</td> <td>509,300</td> <td>L</td> <td>861,300</td> </tr> <tr> <td>T</td> <td>563,200</td> <td>LE</td> <td>980,100</td> </tr> <tr> <td>Z</td> <td>617,100</td> <td>LX</td> <td>1,157,200</td> </tr> <tr> <td>👤</td> <td>368,500</td> <td colspan="2">※張地をご支給の場合</td> </tr> </tbody> </table>	FABRIC		LEATHER		R	455,400	AL	742,500	I	509,300	L	861,300	T	563,200	LE	980,100	Z	617,100	LX	1,157,200	👤	368,500	※張地をご支給の場合	
FABRIC		LEATHER																										
R	455,400	AL	742,500																									
I	509,300	L	861,300																									
T	563,200	LE	980,100																									
Z	617,100	LX	1,157,200																									
👤	368,500	※張地をご支給の場合																										
CHAISE LONGUE (RIGHT) 右肘シェーズロング	ARLES 1705 アルル 1705	ロクロ脚	ビーチ (ウレタン塗装)	<input type="checkbox"/> NL <input type="checkbox"/> WN <input type="checkbox"/> WE																								
				<input type="checkbox"/> WH <input type="checkbox"/> BK																								
	ARLES 1706 アルル 1706	角脚	ビーチ (ウレタン塗装)	<input type="checkbox"/> NL <input type="checkbox"/> WN <input type="checkbox"/> WE																								
				<input type="checkbox"/> WH <input type="checkbox"/> BK																								
W900xD1600xH845 SH380 AH555				<table border="1"> <thead> <tr> <th colspan="2">FABRIC</th> <th colspan="2">LEATHER</th> </tr> </thead> <tbody> <tr> <td>R</td> <td>399,300</td> <td>AL</td> <td>661,100</td> </tr> <tr> <td>I</td> <td>443,300</td> <td>L</td> <td>766,700</td> </tr> <tr> <td>T</td> <td>487,300</td> <td>LE</td> <td>872,300</td> </tr> <tr> <td>Z</td> <td>531,300</td> <td>LX</td> <td>1,023,000</td> </tr> <tr> <td>👤</td> <td>333,300</td> <td colspan="2">※張地をご支給の場合</td> </tr> </tbody> </table>	FABRIC		LEATHER		R	399,300	AL	661,100	I	443,300	L	766,700	T	487,300	LE	872,300	Z	531,300	LX	1,023,000	👤	333,300	※張地をご支給の場合	
FABRIC		LEATHER																										
R	399,300	AL	661,100																									
I	443,300	L	766,700																									
T	487,300	LE	872,300																									
Z	531,300	LX	1,023,000																									
👤	333,300	※張地をご支給の場合																										
CHAISE LONGUE (LEFT) 左肘シェーズロング	ARLES 1707 アルル 1707	ロクロ脚	ビーチ (ウレタン塗装)	<input type="checkbox"/> NL <input type="checkbox"/> WN <input type="checkbox"/> WE																								
				<input type="checkbox"/> WH <input type="checkbox"/> BK																								
	ARLES 1708 アルル 1708	角脚	ビーチ (ウレタン塗装)	<input type="checkbox"/> NL <input type="checkbox"/> WN <input type="checkbox"/> WE																								
				<input type="checkbox"/> WH <input type="checkbox"/> BK																								
W900xD1600xH845 SH380 AH555				<table border="1"> <thead> <tr> <th colspan="2">FABRIC</th> <th colspan="2">LEATHER</th> </tr> </thead> <tbody> <tr> <td>R</td> <td>399,300</td> <td>AL</td> <td>661,100</td> </tr> <tr> <td>I</td> <td>443,300</td> <td>L</td> <td>766,700</td> </tr> <tr> <td>T</td> <td>487,300</td> <td>LE</td> <td>872,300</td> </tr> <tr> <td>Z</td> <td>531,300</td> <td>LX</td> <td>1,023,000</td> </tr> <tr> <td>👤</td> <td>333,300</td> <td colspan="2">※張地をご支給の場合</td> </tr> </tbody> </table>	FABRIC		LEATHER		R	399,300	AL	661,100	I	443,300	L	766,700	T	487,300	LE	872,300	Z	531,300	LX	1,023,000	👤	333,300	※張地をご支給の場合	
FABRIC		LEATHER																										
R	399,300	AL	661,100																									
I	443,300	L	766,700																									
T	487,300	LE	872,300																									
Z	531,300	LX	1,023,000																									
👤	333,300	※張地をご支給の場合																										

ARLES

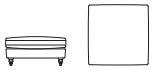
アルル
DESIGN : ATELIER D.O.

ITEM / SIZE	ITEM NO.	LEGS	WOOD	PRICE																								
OTTOMAN オットマン  W780×D780×H380	ARLES 959 アルル 959	ロクロ脚	ビーチ (ウレタン塗装) ■ NL ■ WN ■ WE ■ WH ■ BK	<table border="1"> <thead> <tr> <th colspan="2">FABRIC</th> <th colspan="2">LEATHER</th> </tr> </thead> <tbody> <tr> <td>R</td> <td>166,100</td> <td>AL</td> <td>234,300</td> </tr> <tr> <td>I</td> <td>183,700</td> <td>L</td> <td>262,900</td> </tr> <tr> <td>T</td> <td>201,300</td> <td>LE</td> <td>291,500</td> </tr> <tr> <td>Z</td> <td>218,900</td> <td>LX</td> <td>335,500</td> </tr> <tr> <td>👤</td> <td>138,600</td> <td colspan="2">※張地をご支給の場合</td> </tr> </tbody> </table>	FABRIC		LEATHER		R	166,100	AL	234,300	I	183,700	L	262,900	T	201,300	LE	291,500	Z	218,900	LX	335,500	👤	138,600	※張地をご支給の場合	
				FABRIC		LEATHER																						
R	166,100	AL	234,300																									
I	183,700	L	262,900																									
T	201,300	LE	291,500																									
Z	218,900	LX	335,500																									
👤	138,600	※張地をご支給の場合																										
ARLES 490 アルル 490	角脚	ビーチ (ウレタン塗装) ■ NL ■ WN ■ WE ■ WH ■ BK	<table border="1"> <thead> <tr> <th colspan="2">FABRIC</th> <th colspan="2">LEATHER</th> </tr> </thead> <tbody> <tr> <td>R</td> <td>174,900</td> <td>AL</td> <td>243,100</td> </tr> <tr> <td>I</td> <td>192,500</td> <td>L</td> <td>272,800</td> </tr> <tr> <td>T</td> <td>210,100</td> <td>LE</td> <td>302,500</td> </tr> <tr> <td>Z</td> <td>227,700</td> <td>LX</td> <td>343,200</td> </tr> <tr> <td>👤</td> <td>148,500</td> <td colspan="2">※張地をご支給の場合</td> </tr> </tbody> </table>	FABRIC		LEATHER		R	174,900	AL	243,100	I	192,500	L	272,800	T	210,100	LE	302,500	Z	227,700	LX	343,200	👤	148,500	※張地をご支給の場合		
FABRIC		LEATHER																										
R	174,900	AL	243,100																									
I	192,500	L	272,800																									
T	210,100	LE	302,500																									
Z	227,700	LX	343,200																									
👤	148,500	※張地をご支給の場合																										
OTTOMAN(L) オットマン(L)  W900×D780×H380	ARLES 960 アルル 960	ロクロ脚	ビーチ (ウレタン塗装) ■ NL ■ WN ■ WE ■ WH ■ BK	<table border="1"> <thead> <tr> <th colspan="2">FABRIC</th> <th colspan="2">LEATHER</th> </tr> </thead> <tbody> <tr> <td>R</td> <td>18,700</td> <td>AL</td> <td>31,900</td> </tr> <tr> <td>I</td> <td>20,900</td> <td>L</td> <td>37,400</td> </tr> <tr> <td>T</td> <td>23,100</td> <td>LE</td> <td>42,900</td> </tr> <tr> <td>Z</td> <td>25,300</td> <td>LX</td> <td>52,800</td> </tr> <tr> <td>👤</td> <td>14,300</td> <td colspan="2">※張地をご支給の場合</td> </tr> </tbody> </table>	FABRIC		LEATHER		R	18,700	AL	31,900	I	20,900	L	37,400	T	23,100	LE	42,900	Z	25,300	LX	52,800	👤	14,300	※張地をご支給の場合	
				FABRIC		LEATHER																						
R	18,700	AL	31,900																									
I	20,900	L	37,400																									
T	23,100	LE	42,900																									
Z	25,300	LX	52,800																									
👤	14,300	※張地をご支給の場合																										
ARLES 491 アルル 491	角脚	ビーチ (ウレタン塗装) ■ NL ■ WN ■ WE ■ WH ■ BK	<table border="1"> <thead> <tr> <th colspan="2">FABRIC</th> <th colspan="2">LEATHER</th> </tr> </thead> <tbody> <tr> <td>R</td> <td>20,900</td> <td>AL</td> <td>38,500</td> </tr> <tr> <td>I</td> <td>23,100</td> <td>L</td> <td>46,200</td> </tr> <tr> <td>T</td> <td>25,300</td> <td>LE</td> <td>53,900</td> </tr> <tr> <td>Z</td> <td>27,500</td> <td>LX</td> <td>64,900</td> </tr> <tr> <td>👤</td> <td>16,500</td> <td colspan="2">※張地をご支給の場合</td> </tr> </tbody> </table>	FABRIC		LEATHER		R	20,900	AL	38,500	I	23,100	L	46,200	T	25,300	LE	53,900	Z	27,500	LX	64,900	👤	16,500	※張地をご支給の場合		
FABRIC		LEATHER																										
R	20,900	AL	38,500																									
I	23,100	L	46,200																									
T	25,300	LE	53,900																									
Z	27,500	LX	64,900																									
👤	16,500	※張地をご支給の場合																										
ARM COVER (RIGHT) アームカバー(ソファ右肘用)	ARLES 1544 アルル 1544			<table border="1"> <thead> <tr> <th colspan="2">FABRIC</th> <th colspan="2">LEATHER</th> </tr> </thead> <tbody> <tr> <td>R</td> <td>18,700</td> <td>AL</td> <td>31,900</td> </tr> <tr> <td>I</td> <td>20,900</td> <td>L</td> <td>37,400</td> </tr> <tr> <td>T</td> <td>23,100</td> <td>LE</td> <td>42,900</td> </tr> <tr> <td>Z</td> <td>25,300</td> <td>LX</td> <td>52,800</td> </tr> <tr> <td>👤</td> <td>14,300</td> <td colspan="2">※張地をご支給の場合</td> </tr> </tbody> </table>	FABRIC		LEATHER		R	18,700	AL	31,900	I	20,900	L	37,400	T	23,100	LE	42,900	Z	25,300	LX	52,800	👤	14,300	※張地をご支給の場合	
FABRIC		LEATHER																										
R	18,700	AL	31,900																									
I	20,900	L	37,400																									
T	23,100	LE	42,900																									
Z	25,300	LX	52,800																									
👤	14,300	※張地をご支給の場合																										
ARM COVER (LEFT) アームカバー(ソファ左肘用)	ARLES 1545 アルル 1545			<table border="1"> <thead> <tr> <th colspan="2">FABRIC</th> <th colspan="2">LEATHER</th> </tr> </thead> <tbody> <tr> <td>R</td> <td>20,900</td> <td>AL</td> <td>38,500</td> </tr> <tr> <td>I</td> <td>23,100</td> <td>L</td> <td>46,200</td> </tr> <tr> <td>T</td> <td>25,300</td> <td>LE</td> <td>53,900</td> </tr> <tr> <td>Z</td> <td>27,500</td> <td>LX</td> <td>64,900</td> </tr> <tr> <td>👤</td> <td>16,500</td> <td colspan="2">※張地をご支給の場合</td> </tr> </tbody> </table>	FABRIC		LEATHER		R	20,900	AL	38,500	I	23,100	L	46,200	T	25,300	LE	53,900	Z	27,500	LX	64,900	👤	16,500	※張地をご支給の場合	
FABRIC		LEATHER																										
R	20,900	AL	38,500																									
I	23,100	L	46,200																									
T	25,300	LE	53,900																									
Z	27,500	LX	64,900																									
👤	16,500	※張地をご支給の場合																										
ARM COVER (CHAISE LONGUE RIGHT) アームカバー(シェーズロング右肘用)	ARLES 1546 アルル 1546			<table border="1"> <thead> <tr> <th colspan="2">FABRIC</th> <th colspan="2">LEATHER</th> </tr> </thead> <tbody> <tr> <td>R</td> <td>18,700</td> <td>AL</td> <td>31,900</td> </tr> <tr> <td>I</td> <td>20,900</td> <td>L</td> <td>37,400</td> </tr> <tr> <td>T</td> <td>23,100</td> <td>LE</td> <td>42,900</td> </tr> <tr> <td>Z</td> <td>25,300</td> <td>LX</td> <td>52,800</td> </tr> <tr> <td>👤</td> <td>14,300</td> <td colspan="2">※張地をご支給の場合</td> </tr> </tbody> </table>	FABRIC		LEATHER		R	18,700	AL	31,900	I	20,900	L	37,400	T	23,100	LE	42,900	Z	25,300	LX	52,800	👤	14,300	※張地をご支給の場合	
FABRIC		LEATHER																										
R	18,700	AL	31,900																									
I	20,900	L	37,400																									
T	23,100	LE	42,900																									
Z	25,300	LX	52,800																									
👤	14,300	※張地をご支給の場合																										
ARM COVER (CHAISE LONGUE LEFT) アームカバー(シェーズロング左肘用)	ARLES 1547 アルル 1547			<table border="1"> <thead> <tr> <th colspan="2">FABRIC</th> <th colspan="2">LEATHER</th> </tr> </thead> <tbody> <tr> <td>R</td> <td>20,900</td> <td>AL</td> <td>38,500</td> </tr> <tr> <td>I</td> <td>23,100</td> <td>L</td> <td>46,200</td> </tr> <tr> <td>T</td> <td>25,300</td> <td>LE</td> <td>53,900</td> </tr> <tr> <td>Z</td> <td>27,500</td> <td>LX</td> <td>64,900</td> </tr> <tr> <td>👤</td> <td>16,500</td> <td colspan="2">※張地をご支給の場合</td> </tr> </tbody> </table>	FABRIC		LEATHER		R	20,900	AL	38,500	I	23,100	L	46,200	T	25,300	LE	53,900	Z	27,500	LX	64,900	👤	16,500	※張地をご支給の場合	
FABRIC		LEATHER																										
R	20,900	AL	38,500																									
I	23,100	L	46,200																									
T	25,300	LE	53,900																									
Z	27,500	LX	64,900																									
👤	16,500	※張地をご支給の場合																										

ITEM	WOOD	ITEM NO.	PRICE
MATTE URETHANE FINISH マットウレタン塗装 UPGRADE	ビーチ (マットウレタン塗装) ■ mTG ■ mBK	ARLES 2450 アルル 2450	+13,200

ARLES

アルル

DESIGN : ATELIER D.O.

FEATURES

ARLES ITEM

アルル 商品アイテム

SCALE : 1/100

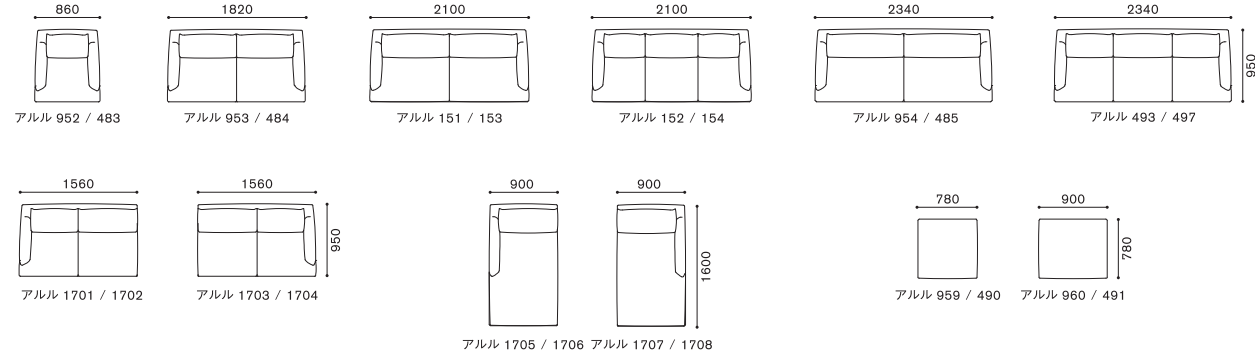

ARLES SET EXAMPLE

アルル セッティング例

SCALE : 1/100

